

MXL-INSTPR

REV 3

11/19

macnaught

TYPE PR DIGITAL REGISTER

INSTRUCTION MANUAL



- FLOWRATE INDICATOR
- TOTALIZER

To the Owner

Please read and retain this instruction manual to assist you in the operation of this product.

This Instruction Manual provides instruction guide on the operation and programming of the Type PR, 12mm LCD Digital Register.

Should you require further assistance please contact your local Macnaught representative.

Macnaught offer a comprehensive set of web based support materials to compliment our product range. Access the website by scanning the QR code.



WWW.MACNAUGHT.COM

INDEX

Introduction	3
Functions and Features.....	3
Configuration.....	3
Display and mounting information.....	3
Installation.....	3
Warranty.....	3
Technical Specifications	4
General.....	4
Display.....	4
Input.....	4
Output.....	4
Set-up functions	5
Terminal connectors	5
Explanation of Set-up functions	6
Total/ Batch Total.....	6
Accumulated Total.....	6
Flow Rate.....	6
Meter.....	6
Programming Set-up level	7
Modes of operation.....	7
Function of buttons.....	7
Entering and Exiting Setup mode.....	7
K-factor programming	8
How to find a k-factor of your meter.....	8
Entering K-factor in the display.....	8
Gallons to Litre conversion.....	8
Dimensions	9
Exploded view	9
Ordering code	9
Service kits	9
Troubleshooting	10
Replacing the battery.....	10
Notes	11

INTRODUCTION

FUNCTIONS AND FEATURES

The flow rate / totalizer model PR is a microprocessor driven instrument designed to display flow rate, total and accumulated total.

This product has been designed with a focus on:

- Ultra-low power consumption to allow long-life battery powered applications.
- The glass reinforced polypropylene housing offers IP67 environmental protection.

CONFIGURATION OF THE UNIT

The PR has been designed to be implemented in many types of applications. For that reason, a SETUP-level is available to configure your PR according to your specific requirements.

It includes several important features, such as K-factors, measurement units etc. All settings are stored in EEPROM memory and will not be lost in the event of power failure.

DISPLAY INFORMATION

The unit has a large transfective LCD with various kinds of symbols and digits to display measuring units, status information and key-word messages.

Flowrate and total are displayed on 12mm digits.

A backup of the total and accumulated total in EEPROM memory is made every minute.

MOUNTING EXAMPLES

Mounting on MX meter body



Mounting on wall mount bracket



DISPLAY EXAMPLES

Flow rate example



Total example

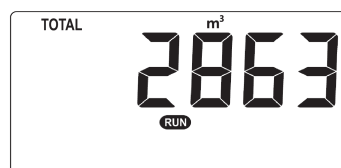

Display features Decimals and various units of measurement

INSTALLATION

The display has a unique M-lock mounting feature. It can be installed on

- MX meter body
- MX wall mount bracket

To install, secure the display on the cam and rotate quarter turn clock-wise (90 degrees)

To uninstall, hold the display and rotate quarter turn anti clock-wise (90 degrees)



There are no tools required to install/ remove the display

WARRANTY

For warranty terms & conditions, visit <https://au.macnaught.com/warranty>

TECHNICAL SPECIFICATIONS

GENERAL

Display

Type	High intensity reflective numeric and alphanumeric LCD, UV-resistant
Digits	Seven 12mm (0.47") and seven 8mm (0.31"). Various symbols and measuring units
Refresh rate	Flow Rate: Once per second
	Total: 8 times/second after key press to one second

Enclosure

General	Polypropylene housing with Polycarbonate window, EPDM gaskets. UV stabilized
Control keys	Two industrial micro-switch keys. UV-resistant keypad.
IP Classification	IP67
Cable entry	(2) x M12 * 1.5
Backlight	No
Ex approvals	No

Temperature

Operational	-20°C to +80°C (-4°F to +176°F).
-------------	----------------------------------

Power supply

Battery powered	Lithium battery - life-time depends upon settings - up to 3 years @ 20°C
Battery specs	3.6 VDC, 'A' size, type: ER17505 (Ordering code: DR012S)

Terminal connections

Type	Terminal strip. Wire max. 1mm ²
------	--

Data protection

Type	Backup of all settings and running totals in flash memory
------	---

Environment

Electromagnetic compatibility	Compliant ref: EN 61326-1:2006, EN61010-1:2001
-------------------------------	--

DISPLAY

Flow rate / Total / Batch total / Accumulated total

(Note: Total and Batch total can be reset to zero)

Digits	7 digits
Units	L - m ³ - UKGAL - USGAL - UKbbl - USbbl - OILbbl
Decimals	0 - 1 - 2 or 3.

Flow Rate

Time units	/sec - /min - /hr
------------	-------------------

Operator functions

Displayed functions	Flow Rate.
	Total (can be reset to zero by the operator).
	Batch total (can be reset to zero by the operator)
	Accumulated total (non resettable)

INPUT & OUTPUT

Input

Input	Reed switch (from flow meter)
Frequency	Total: minimum 0 Hz - maximum 120 Hz for total
	Flow Rate: 0.01 Hz – maximum 120 Hz
K-Factor	0000.001 - 9,999.999 pulses per Litre

Output

Output	Nil
--------	-----

SET-UP FUNCTIONS

1 Total/ Batch Total			Default value
1.1	Unit	L - m ³ - UKGAL - USGAL - UKbbl - USbbl - OILbbl	L
1.2	Decimals	0 - 1 - 2 - 3	0
2 Accumulated Total			
2.1	Unit	L - m ³ - UKGAL - USGAL - UKbbl - USbbl - OILbbl	L
2.2	Decimals	0 - 1 - 2 - 3	0
3 Flow Rate			
3.1	Unit	L - m ³ - UKGAL - USGAL - UKbbl - USbbl - OILbbl	L
3.2	Time Period	Second - Minute - Hour	Minutes
3.3	Decimals	0 - 1 - 2 - 3	0
3.4	Calculation	per 1 - 255 pulses	10
3.5	Cut-off	0.1 - 999.9 seconds	30
4 Meter			
4.1	*K-Factor (Pulses per Litre)	0000.000 to 9999.999	'1' or as per factory settings
5 Others			
5.1	Type	dr	dr
5.2	Software Version	03.xx.xx	03.xx.xx
5.3	Serial No.	xxxxxxx	xxxxxxx



IMPORTANT

The settings for Total, Accumulated Total and Flow rate are entirely separate. In this way, different units of measurement and decimals can be used for each e.g. gallons for total and liters for flow rate.

The K-Factor in 4.1 must be entered in pulses per litre (PPL). Entering the k-factor in pulses per gallon (PPG) will result in inaccurate readings. Refer to page 8 for detailed instruction on entering the k-factor.



***The k-factor in 4.1 MUST ALWAYS be entered in pulses per LITRE, regardless of units in 1.1, 2.1 and 3.1**

Note !

TERMINAL CONNECTORS

The PR unit can only accept a Reed switch input, this sensor has been selected as the most common sensor and requires very little power with small effect on battery life.

The 2 position terminal block is not polarity conscious so the reed switch wires can be connected in any order.

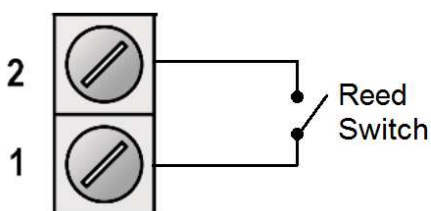

Note !

For meter mounted displays, these terminals come connected from factory. No further connections are required by end-user.

For remote displays, Reed switch (from flow meter) to be connected by the end-user.



Connecting any other type of sensor could cause damage to the unit

EXPLANATION OF SET-UP FUNCTIONS

1 Total/ Batch Total		
1.1	Unit	This determines the measurement unit for Total and Batch total. The following units can be selected: L - m ³ - UKGAL - USGAL - UKbbl –USbbl - OILbbl
1.2	Decimals	This determines the number of digits and decimal points for total and batch total. The following decimals can be selected (for 0, 1, 2 and 3 respectively) 0000000 - 111111.1 - 22222.22 - 3333.333
2 Accumulated Total		
2.1	Unit	This determines the measurement unit for Accumulated Total. The following units can be selected: L - m ³ - UKGAL - USGAL - UKbbl –USbbl - OILbbl
2.2	Decimals	This determines the number of digits and decimal points for accumulated total. The following decimals can be selected (for 0, 1, 2 and 3 respectively) 0000000 - 111111.1 - 22222.22 - 3333.333
3 Flow Rate		
3.1	Unit	This determines the measurement unit for flow rate. The following units can be selected: L - m ³ - UKGAL - USGAL - UKbbl –USbbl - OILbbl
3.2	Time Period	This determines the time unit for flow rate The following units can be selected: /SEC (Second) - /MIN (Minute) - / HR (Hour)
3.3	Decimals	This determines the number of digits and decimal points for flow rate. The following decimals can be selected (for 0, 1, 2 and 3 respectively) 0000000 - 111111.1 - 22222.22 - 3333.333
3.4	Calculation	The flow rate is calculated by measuring the time between a number of pulses, for example 10 pulses. The more pulses the more accurate the flow rate will be. The maximum value is 255 pulses. Note: the lower the number of pulses, the higher the power consumption of the unit will be (important for battery powered applications). Note: for low frequency applications (below 10Hz): do not program more than 10 pulses else the update time will be very slow. Note: for high frequency application (above 1kHz) do program a value of 100 or more pulses.
3.5	Cut-off	With this setting, you determine a minimum flow requirement thresh-hold, if during this time less than XXX-pulses (setup 3.4) are generated, the flow rate will be displayed as zero. The cut-off time has to be entered in seconds - maximum time is 999 seconds (about 15 minutes).
4 Meter		
4.1	*K-Factor (Pulses per Litre)	With the K-factor, the flow meter pulse signals are converted to a flow rate. The more accurate the K-factor, the more accurate the functioning of the system will be. The setting allows a K Factor with up to 3 decimal places and 4 whole numbers e.g. 1234.123 *Please note that the K-Factor entered in 4.1 must be in pulses per litre (PPL). Entering the k-factor in pulses per gallon (PPG) will result in inaccurate readings. Refer to page 8 for detailed instruction on programming the k-factor.



IMPORTANT

The settings for Total, Accumulated Total and Flow rate are entirely separate. In this way, different units of measurement and decimals can be used for each e.g. gallons for total and liters for flow rate.

PROGRAMMING SET-UP LEVEL

This chapter describes the daily use and programming of the PR Digital Register. The instructions are meant for users / operators.

MODES OF OPERATION

RUN mode: This is the normal operating mode. **RUN** icon on the screen represents this mode.

SETUP mode: This mode is to view settings. **SET-UP** icon on the screen represents this mode.

SETUP PROG mode: This mode is to modify settings. **SET-UP PROG** icon on the screen represents this mode.

FUNCTION OF THE BUTTONS

Below are the functions of 'P' and 'S' buttons during different modes of operation.

Mode	P	S	P S (Press and release simultaneously)
RUN	Toggle screens; Flowrate, Total, Batch and Accumulated total Access to Setup mode	Toggle screens; Flowrate, Total, Batch and Accumulated total	Resets Total and Batch total (Press P for NO or S for YES when prompted)
SETUP	Toggle sub-functions Access to Run mode	Toggle main-functions	Access to Setup-Prog mode (while in a sub-function)
SETUP PROG	Apply a new value to a sub-function	Apply a new value to a sub-function	Save changes

Setup mode is reached by pressing the 'P' button for 7 seconds; at which time, setup will be displayed on the LC display. In order to return to the Run mode, 'P' will have to be pressed for 3 seconds. Alternatively, if no keys are pressed for 2 minutes, the unit will exit setup mode automatically.

Setup can be reached at all times while the display remains fully operational.

ENTERING INTO SETUP MODE

EXITING FROM SETUP MODE

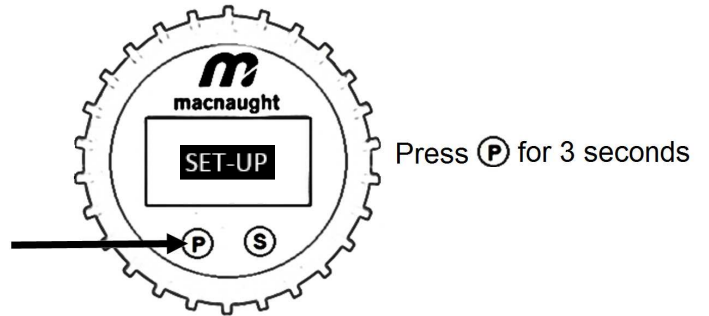
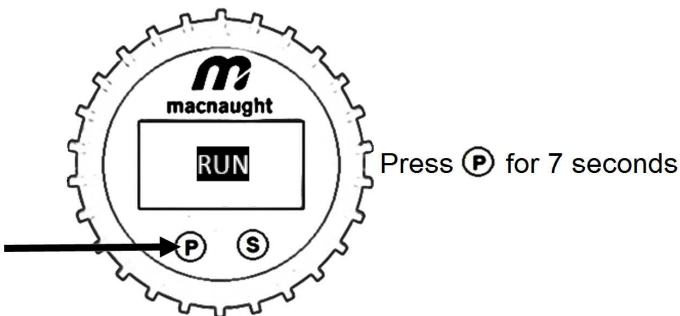

Once programming is done, visit the parameters again to make sure the changes are saved correctly.

K-FACTOR PROGRAMMING

HOW TO FIND A K-FACTOR OF YOUR METER

The K-factor could be found on either of;

- Flow meter's body
- Flow meter's test report
- Contact Macnaught providing the Serial Number of the flow meter

PROGRAMMING K-FACTOR IN THE DISPLAY

Always enter the K-factor in **pulses per LITRE (PPL)**. Entering the k-factor in pulses per gallon (PPG) will result in inaccurate readings.

Follow below steps to enter the k-factor if you are in RUN mode

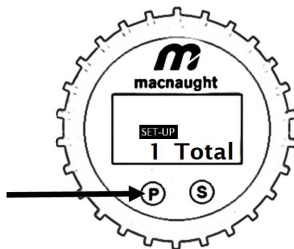

Press **P** for 7 seconds.

This will enter into Setup model

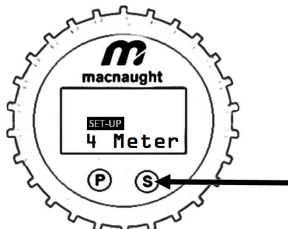

Press **S** three times until it shows function 4 'METER'

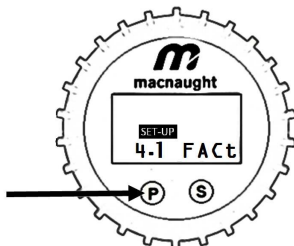

Press **P**

This will show sub-function 4.1 'FACT (i.e. K-factor)'

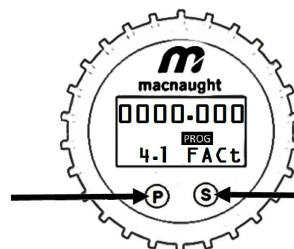

Press and release **P** and **S** simultaneously

This will enter in programming mode. The screen show **PROG** and the left most digit start flashing

Press **P** to change the numeric value and press **S** to move to the next digit.

Once the k-factor is entered, press and release **P** and **S** simultaneously. This will save the changes.

Press **P** for 3 seconds to go to the Run mode

PPG to PPL Conversion

If the flow meter's body or test report shows the k-factor in pulses per gallon (PPG), it needs to be converted into pulses per LITRE (PPL) first.

Divide the PPG k-factor by **3.7854** to convert into PPL.

As an example: If the PPG k-factor is 136.70, the PPL k-factor is 36.112



The display accepts k-factor in pulses per LITRE only
Note! Once the programming is done, visit the parameters again to make sure the changes are saved correctly

DIMENSIONS

Display

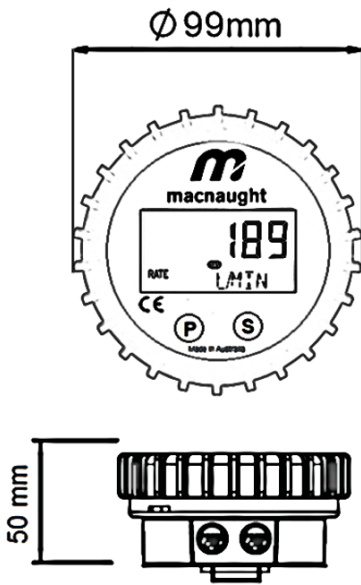

Wall Mount bracket

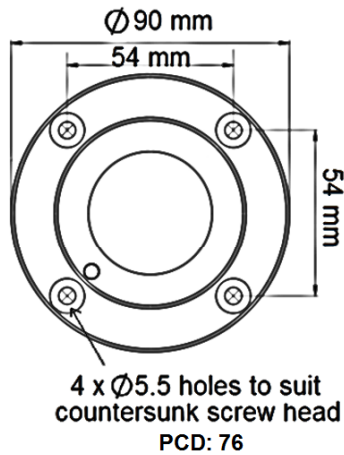

Display with Wall Mount bracket

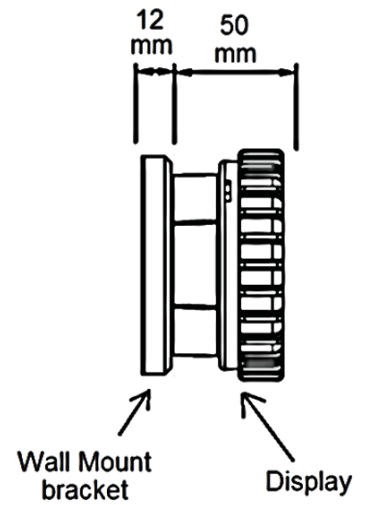

EXPLODED VIEW

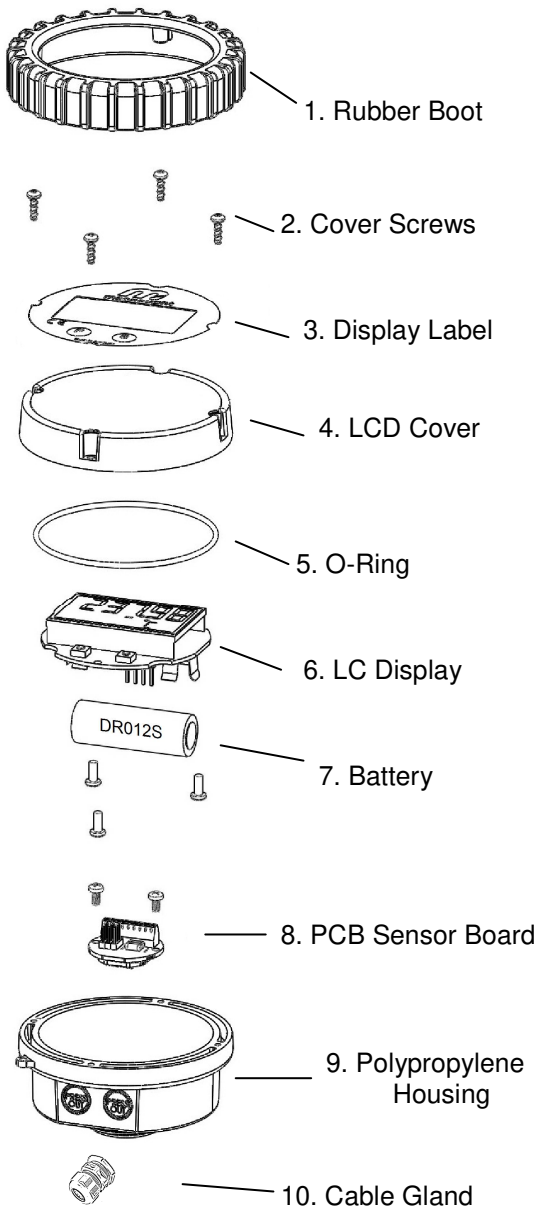

ORDERING CODE

Part Number	Item Description
MXD-DS	Display
MXS-WMB	Wall mount bracket
PR-RMP	Display + Wall mount bracket



Wall mount bracket is required for remote installation

SERVICE KITS

Kit Part Number	Item Description	Item Number
DR012S	Battery	7
MXS-PCB-RH	PCB Sensor Board	8
MXS-PCB-PR	PCB Sensor Board	8
	PP Housing	9
MS1279S	Display Label	3
MS685S	Cable gland - M12	10
MXS-DIS-PR	Cover Screws	2
	Display Label	3
	LCD Cover	4
	O-Ring	5
	LC Display	6
	Battery	7



PCB Sensor Board has 1 x Reed switch and 1 x Hall effect sensor as standard (unless a special board is requested)

Note !

TROUBLESHOOTING

DISPLAY IS BLANK

The battery could either be dead or not connected properly. Inspect/ replace the battery.

DISPLAY SHOWS INCORRECT READING

Check the k-factor. Make sure the decimals are taken care of. It should be in pulses per litre.

DISPLAY SHOWS NO FLOW

Check the wiring between the PCB sensor board (Item no 8) and LC display board (Item no 6). Check for loose connections and clean the terminals if required. Replace the PCB sensor board if wiring and programming are ok.

bAt LOW ALARM

This is Low Battery alarm. Replace the battery

RPL bAt ALARM

This is the final warning of low battery. The unit will shutdown any time. Replace battery

REPLACING THE BATTERY

The battery is located on the rear side of LC display (item no 6). This can be accessed by removing the rubber boot (item no 1) and screws (item no 2). After replacing the battery (Part no: DR012S), make sure the o-ring (item no 5) stays intact with the LCD cover. Apply a thin layer of grease to the o-ring if required.

Re-install the cover, screws and boot. See illustration below;

1. Remove Rubber Boot

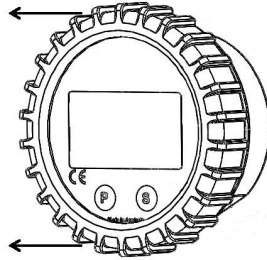

2. Remove 4 screws

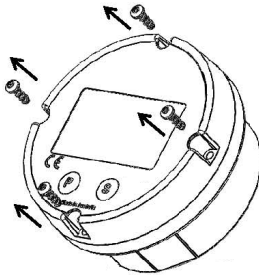

3. Install the battery with orientation as shown

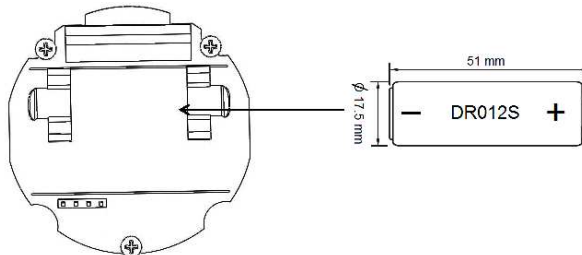

4. Re-install the cover, screws and boot

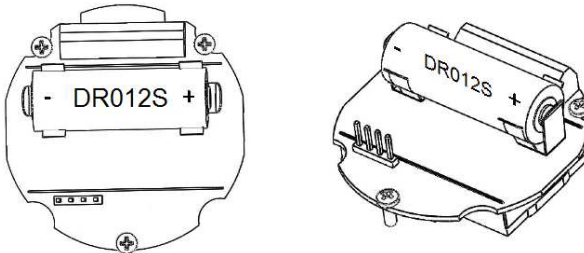

Note !

Backup of settings and running totals are stored in flash memory. The display will retain these values in an event if battery is removed for replacement.



The unit is not intended to be supplied power from an external DC source. Connecting an external source may cause damage or incorrect functioning of the unit.

NOTES

For your record, it is advisable to note down any changes in the parameters

PO/ Reference no: _____

Flow Meter model: _____

Flow meter Serial: _____

1 Total/ Batch Total		Default settings	Date: __/__/____	Date: __/__/____
			Enter your settings here	Enter your settings here
1.1	Unit	L - m ³ - UKGAL - USGAL - UKbbl - USbbl - OILbbl	L	
1.2	Decimals	0 - 1 - 2 - 3	0	
2 Accumulated Total				
2.1	Unit	L - m ³ - UKGAL - USGAL - UKbbl - USbbl - OILbbl	L	
2.2	Decimals	0 - 1 - 2 - 3	0	
3 Flow Rate				
3.1	Unit	L - m ³ - UKGAL - USGAL - UKbbl - USbbl - OILbbl	L	
3.2	Time Period	Second - Minute - Hour	Minutes	
3.3	Decimals	0 - 1 - 2 - 3	0	
3.4	calculation	per 1 - 255 pulses	10	
3.5	Cut-off	0.1 - 999.9 seconds	30	
4 METER				
4.1	*K-Factor (Pulses per Litre)	0000.000 to 9999.999	'1' or as per factory settings	
5 OTHERS				
5.1	Type	dr	dr	
5.2	Software Version	03.xx.xx	03.xx.xx	
5.3	Serial No.	xxxxxxx	xxxxxxx	

WEEE Directive - Waste Electrical and Electronic Equipment



The WEEE Directive requires the recycling of waste electrical and electronic equipment in the European Union.

Whilst the WEEE Directive does not apply to some of Macnaught's products, we support its policy and ask you to be aware of how to dispose of this product.

The crossed out wheeie bin symbol illustrated and found on our products signifies that this product should not be disposed of in general waste or landfill.

Please contact your local dealer national distributor or Macnaught Technical Services for information on product disposal.



Macnaught Pty Limited

ABN 66 000 075 785

41-49 Henderson Street
Turrella NSW 2205 Sydney Australia
Postal Address PO Box 90
Arncliffe NSW 2205 Sydney Australia

T: +61 2 9567 0401

F: +61 2 9597 7773

W: www.macnaught.com.au